

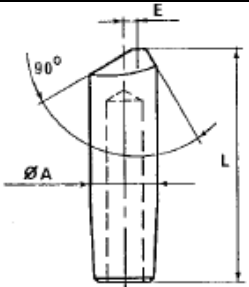









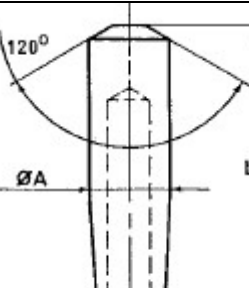

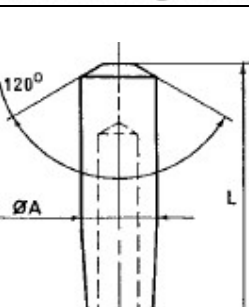

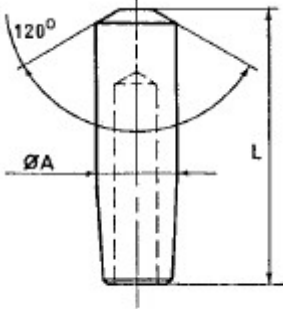

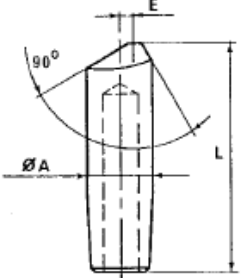

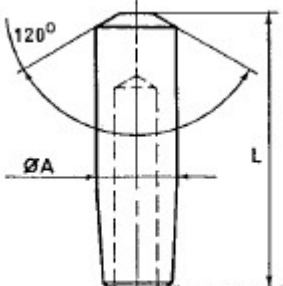

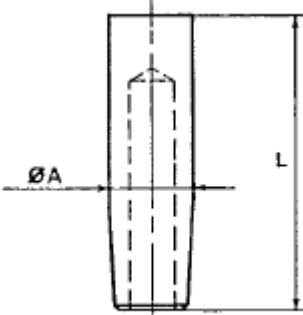
Cône normalisé à 10%, diamètre 13 mm

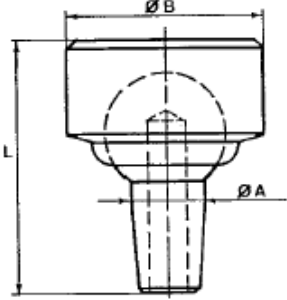

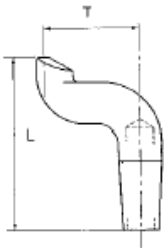
<p>FSG47 134002</p>		 <p><i>Électrode droite, grain déporté</i></p>	<p>Dia cône (mm) 13 Dia point (mm) 4 Déport point (E) 5 Longueur totale (mm) 40</p>
<p>FSG48 134004</p>		 <p><i>Électrode droite, grain centré</i></p>	<p>Dia cône (mm) 13 Dia point (mm) 4 Longueur totale (mm) 40</p>
<p>FSG49 135004</p>		 <p><i>Électrode droite, grain centré</i></p>	<p>Dia cône (mm) 13 Dia point (mm) 4 Longueur totale (mm) 50</p>

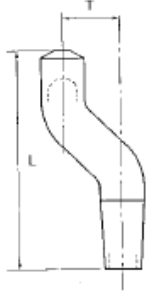
Cône normalisé à 10%, diamètre 16 mm

<p>FSG50 164004</p>		 <p><i>Électrode droite, grain centré</i></p>	<p>Dia cône (mm) 16 Dia point (mm) 4 Longueur totale (mm) 40</p>
<p>FSG51 165002</p>		 <p><i>Électrode droite, grain déporté</i></p>	<p>Dia cône (mm) 16 Dia point (mm) 4 Déport point (E) 6 Longueur totale (mm) 50</p>
<p>FSG52 165004</p>		 <p><i>Électrode droite, grain centré</i></p>	<p>Dia cône (mm) 16 Dia point (mm) 4 Longueur totale (mm) 50</p>
<p>FSG53 165005</p>		 <p><i>Électrode droite plate</i></p>	<p>Dia cône (mm) 16 Longueur totale (mm) 45</p>

<p>FSG54 166031</p>		 <p><i>Électrode à rotule</i></p>	<p>Dia cône (mm) 16 Dia rotule (mm) 30 Longueur totale (mm) 53</p> <p>Permet de minimiser le marquage sur une des deux tôles et de récupérer des problèmes d'alignement</p>
<p>FSG56 166319</p>		 <p><i>Électrode déportée, grain déporté</i></p>	<p>Dia cône (mm) 16 Dia point (mm) 5 Déport point (E) 35 Longueur totale (mm) 60</p>
<p>FSG57 168017</p>		 <p><i>Électrode double courbure, grain centré</i></p>	<p>Dia cône (mm) 16 Dia point (mm) 6 Déport (T) 25 Longueur totale (mm) 80</p>
<p>FSG58 168018</p>		 <p><i>Électrode double courbure, grain déporté</i></p>	<p>Dia cône (mm) 16 Dia point (mm) 4 Déport (T) 25 Longueur totale (mm) 80</p>

Cône normalisé à 10%, diamètre 20 mm

FSG59 2010018		 <p><i>Électrode double courbure, grain déporté</i></p>	<table><tr><td>Dia cône (mm)</td><td>20</td></tr><tr><td>Dia point (mm)</td><td>7</td></tr><tr><td>Déport (T)</td><td>25</td></tr><tr><td>Longueur totale (mm)</td><td>100</td></tr></table>	Dia cône (mm)	20	Dia point (mm)	7	Déport (T)	25	Longueur totale (mm)	100
Dia cône (mm)	20										
Dia point (mm)	7										
Déport (T)	25										
Longueur totale (mm)	100										